



Lift &
Slide
Door

The architect's choice



AP400 LIFT & SLIDE DOOR

All Frames Direct Lift & Slide doors are manufactured from thermally broken aluminium material. These sleek, stylish, and highly durable doors with large glass area achieves panoramic impact without compromising on security or energy efficiency.

Invite the outside in and discover your options with our striking Lift & Slide doors.

Beautiful,
Elegant
&
Secure

The Finer *Details*

- A totally vertical lifting mechanism
- Aluminium extruded profiles with sharp, crisp lines
- 24mm polyamide high performance thermal barrier
- Thermal U-Value performance up to 1.3W / m2K
- Glazing options 28mm to 42mm
- It will support configurations of up to 300kg per sash - with options of up to 400kg
- Sliding leaf max. 3300mm wide by 3000mm high
- Bespoke reinforced resin wheels for near silent operation
- Innovative rotational cleaning system synchronised by wheel movement
- Zinc plated metallic operating system for additional corrosion resistance
- All metal mechanism for extended strength and longevity



Design *Excellence*

The right door can transform a space. It can change your kitchen or living area by allowing natural light to penetrate deep into your home.

Our aluminium Lift & Slide doors offer seamless operation, providing slimline, robust and secure options that are fully customisable.

The larger lift and slide doors are perfect for wider openings in new builds, extension and renovation projects, offering expert engineering, innovative design and increased natural light.

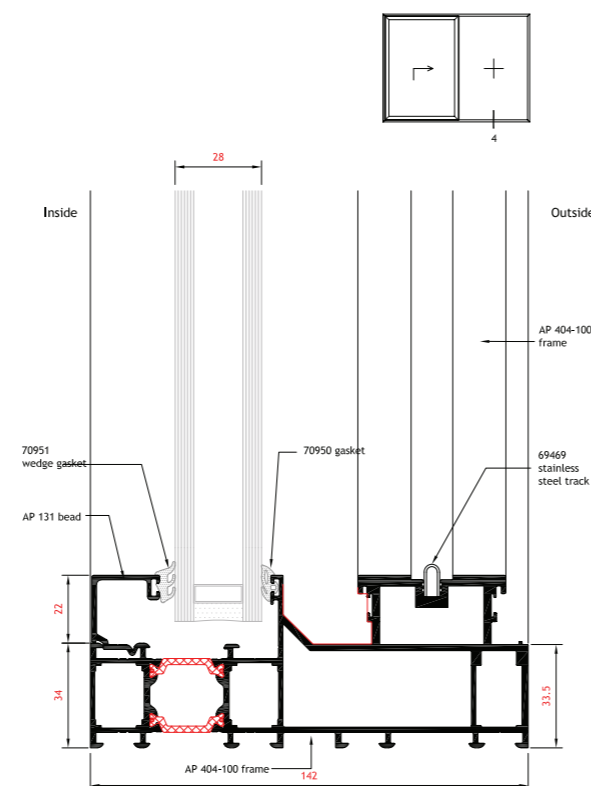

A fantastic addition to any building

Door Options

Smooth operation
of your doors for years to come

2 Pane - 1 Side

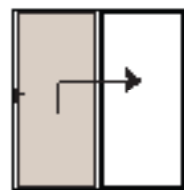

3 Pane - 1 Side

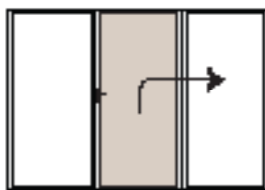

4 Pane - 2 Side

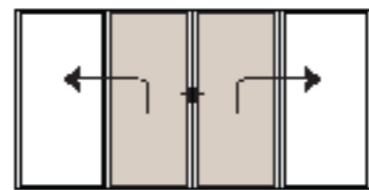

This modern and architecturally attractive style comes in two, three and four pane options. The strong long-lasting gear and boggy wheel can lift weight of up to 400kg allowing for large opening doors with a smooth, silent and effortless operation.

- Dynamic cleaning mechanism to prolong lifespan
- Balanced lifting technology to ease operational effort
- Soft-lift damping
- Multi-point high security locking system with optional night latch for ventilation

Maximum Frame Size / Door Weight			
	Frame Width (mm)	Frame Height (mm)	Door Weight (Kg)
Two Panel	5900	2800	300
Four Panel	11800	2800	300

Handle Range

Operating handle internally with finger grip outside - optional external handle to outside. Manufactured with a multipoint high security locking system and finished in satin colour as standard. *Chrome finish is also available.

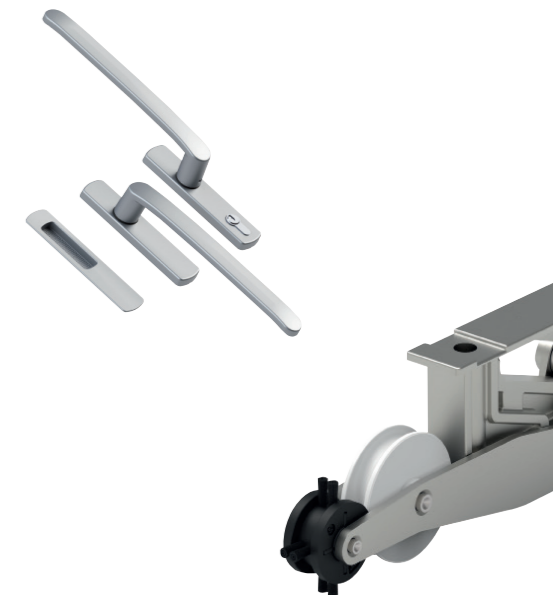

Glazing

The roller feature means that large glass up to 400kg in weight can be opened and closed with little effort. The door system is designed to accommodate 28mm or 42mm double glazing and triple glazed, internally or externally.



Versatile



A choice of colours

Small things like a colour choice can enhance the already striking feature that is your Lift & Slide door. Our systems are supplied in a range of finishes, colours and styles, providing the end user with the ultimate selection to complement their interior and exterior architectural design.

The finish to the aluminium profile is a factory applied Polyester Power Coated finish (PPC), offering durability and exceptional weather protection.

Our range of finishes are available in both single & dual colours.



Outstanding Thermal Efficiency

Each door is designed to insulate for warmth during the winter and for cooling during the summer, helping you to effectively manage energy efficiency within your home or business.

The combination of polyamide thermal breaks and crosslinked polyethylene foam combined with the use of high performance glazed units and large size sliders all lead to its higher thermal performance.

Easy To Maintain

Smooth and glossy interior and exterior surfaces for a refined appearance and easy maintenance.

Robust Performance

Tested to BS6375:PT1	
Water tightness	300pa
Air permeability	600pa
Water penetration	zero
Wind resistance	1200pa

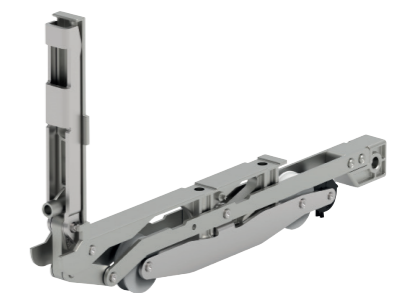

Simple to operate

Open up a room in an instant!

Lift and Slide doors are ideal showstoppers and can make for a real feature point. These doors open parallel to a static panel frame, creating large, impressive entrances to nature.

Once the handle is lifted the easy opening mechanism is deployed and upon closing the door is lowered for good weather seals and air leakage reductions.

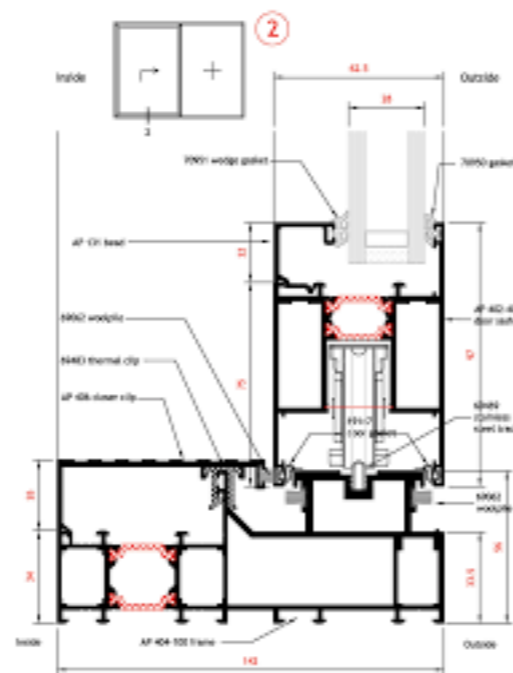

Complete to your liking

Combining uninterrupted views, flexible design and fantastic aesthetics the AP400 Lift and Slide door will help you bring the outdoors in.

Modern, sleek and highly popular, it's the perfect door. Contact one of our fitters today and start seeing the transformation you can achieve with one of our Lift & Slide doors.



Create an extra feeling of space

Lift & Slide Door



Frames Direct
Straboe,
Buncrana,
Co. Donegal,
F93 FF96
Ireland

Tel: 00353 74 9363888
Fax: 00353 74 9362203
info@framesdirect.ie
www.framesdirect.ie



Superior Trade Frames
5 Berkshire Road,
Ballyharry Business Park,
Donaghadee Rd,
Newtownards,
BT23 7HH,
United Kingdom

Tel: 028 91 825740
Fax: 028 91 821374
info@superiortradeframes.com
www.superiortradeframes.com



Futura Frames
Lauragh IDA Industrial Estate,
Bandon,
Co. Cork,
P72 WD21
Ireland

Tel: 00353 (0) 238843870
Fax: 00353 (0) 238843805
orders@futuraframes.ie
www.futuraframes.ie